

Panasonic®

Mobile DVD-Video Player with 96 kHz 24 bit D/A Converter
Lecteur DVD-Vidéo mobile avec décodeur vidéo MPEG II intégré
Reproductor Movil de DVD-VIDEO con Decodificador MPEG Integrado

CX-DVP292U

Operating Instructions
Manuel d'instructions
Manual de instrucciones



MP3



- Please read these instructions carefully before using this product and save this manual for future use.
- Prière de lire ces instructions attentivement avant d'utiliser le produit et garder ce manuel pour l'utilisation ultérieure.
- Lea con atención estas instrucciones antes de utilizar el producto y guarde este manual para poderlo consultar en el futuro.

WARNING:
TO REDUCE THE RISK OF FIRE OR ELECTRIC SHOCK, DO NOT EXPOSE THIS PRODUCT TO RAIN OR MOISTURE.
TO REDUCE THE RISK OF FIRE OR ELECTRIC SHOCK, AND ANNOYING INTERFERENCE, USE ONLY THE INCLUDED COMPONENTS.

WARNING:
NOT FOR USE WHERE VIDEO MONITOR IS VISIBLE TO DRIVER TO AVOID RISK OF SERIOUS INJURY OR POSSIBLE VIOLATION OF STATE LAWS.

Laser products:
Wave length: 650 nm
Laser power: No hazardous radiation is emitted with safety protection.

CAUTION:
THIS PRODUCT IS A CLASS I LASER PRODUCT. HOWEVER THIS PRODUCT USES A VISIBLE/ INVISIBLE LASER BEAM WHICH COULD CAUSE HAZARDOUS RADIATION EXPOSURE IF DIRECTED. BE SURE TO OPERATE THIS PRODUCT CORRECTLY AS INSTRUCTED.
USE OF CONTROLS OR ADJUSTMENTS OR PERFORMANCE OF PROCEDURES OTHER THAN THOSE SPECIFIED HEREIN MAY RESULT IN HAZARDOUS RADIATION EXPOSURE.
DO NOT OPEN COVERS AND DO NOT REPAIR YOURSELF. REFER SERVICING TO QUALIFIED PERSONNEL.

Apparatus Claims of U.S. Patent Nos. 4,631,603, 4,577,216, and 4,819,098, licensed for limited viewing uses only.
This product incorporates copyright protection technology that is protected by method claims of certain U.S. patents and other intellectual property rights owned by Macrovision Corporation and other rights owners. Use of this copyright protection technology must be authorized by Macrovision Corporation, and is intended for home and other limited viewing uses only unless otherwise authorized by Macrovision Corporation. Reverse engineering or disassembly is prohibited.

Label indication and location

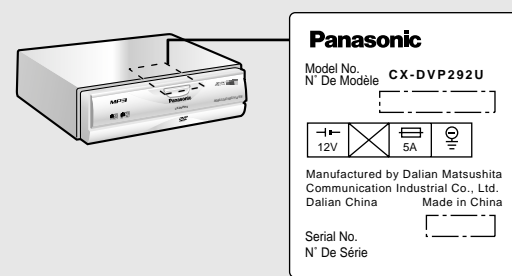

MISE EN GARDE:
POUR RÉDUIRE LES RISQUES D'INCENDIE OU D'ÉLECTROCUTION, N'EXPOSEZ PAS CET APPAREIL À LA PLUIE OU À L'HUMIDITÉ.
AFIN DE PRÉVENIR TOUT RISQUE D'INCENDIE OU D'INTERFÉRENCES, UTILISER UNIQUEMENT LES COMPOSANTS FOURNIS.

MISE EN GARDE:
POUR ÉVITER TOUT RISQUE DE BLESSURES GRAVES OU D'INFRACTION AUX LOIS, LE MONITEUR NE DOIT PAS ÊTRE UTILISÉ À UN ENDROIT OÙ IL SOIT VISIBLE PAR LE CONDUCTEUR.

Produits laser:
Longueur d'onde: 650 nm
Puissance du laser: Aucune radiation dangereuse n'est émise avec la protection de sécurité.

ATTENTION :
CET APPAREIL EST UN PRODUIT LASER DE CLASSE I. IL UTILISE, TOUTEFOIS, UN RAYON LASER VISIBLE/INVISIBLE POUVANT EXPOSER À UN RAYONNEMENT DANGEREUX S'IL EST DIRIGÉ. UTILISEZ CET APPAREIL CORRECTEMENT EN SUIVANT LES INSTRUCTIONS.
L'UTILISATION DE COMMANDES OU RÉGLAGES OU L'EXÉCUTION D'OPÉRATIONS AUTRES QUE CELLES QUI SONT INDIQUÉES DANS CE DOCUMENT PEUVENT RÉSULTER EN UNE EXPOSITION À UN RAYONNEMENT DANGEREUX.
N'OUVREZ PAS LES COUVERCLES ET N'ESSAYEZ PAS D'EFFECTUER VOUS-MÊME DES RÉPARATIONS. ADRESSEZ-VOUS À UN PERSONNEL QUALIFIÉ POUR TOUTE RÉPARATION.

Cet appareil détient les brevets américains no 4,631,603, 4,577,216 et 4,819,098, qui n'autorisent son utilisation que pour des visionnements privés.
Cet appareil incorpore une technologie anti-piratage protégée par des brevets déposés auprès des autorités du gouvernement américain et d'autres droits de propriété intellectuelle détenus par Macrovision Corporation et d'autres détenteurs de droits. L'utilisation de cette technologie anti-piratage doit être autorisée par la société Macrovision et doit se limiter à des fins de divertissement privé à moins d'une autorisation préalable et explicite de Macrovision Corporation. Toute rétro-ingénierie ou tout démontage est interdit.

ADVERTENCIA:
PARA REDUCIR EL RIESGO DE INCENDIOS O SACUDIDAS ELÉCTRICAS, NO EXPONGA ESTE PRODUCTO A LA LLUVIA NI A LA HUMEDAD.
PARA REDUCIR EL RIESGO DE INCENDIOS O SACUDIDAS ELÉCTRICAS, Y PARA EVITAR LAS INTERFERENCIAS MOLESTAS, UTILICE SOLAMENTE LOS COMPONENTES INCLUIDOS.

ADVERTENCIA:
ESTE APARATO NO DEBE UTILIZARSE DONDE EL CONDUCTOR PUEDA VER EL MONITOR DE VÍDEO, PARA EVITAR ACCIDENTES GRAVES O POSIBLES VIOLACIONES DE LAS LEYES ESTATALES.

Productos láser:
Longitud de onda: 650 nm
Potencia láser: Con protección de seguridad no se emite radiación peligrosa.

PRECAUCIÓN:
ÉSTE ES UN PRODUCTO LÁSER DE LA CLASE I. SIN EMBARGO, ESTE PRODUCTO UTILIZA UN RAYO LÁSER VISIBLE/INVISIBLE QUE PODRÍA CAUSAR UNA EXPOSICIÓN PELIGROSA A LA RADIACIÓN. ASEGÚRESE DE UTILIZAR CORRECTAMENTE ESTE PRODUCTO, COMO SE INDICA EN LAS INSTRUCCIONES.
LA UTILIZACIÓN DE CONTROLES, EL HACER AJUSTES O EL SEGUIR PROCEDIMIENTOS DISTINTOS DE LOS ESPECIFICADOS EN ESTE MANUAL PODRÍA CAUSAR UNA EXPOSICIÓN PELIGROSA A LA RADIACIÓN.
NO ABRA LAS CUBIERTAS NI HAGA REPARACIONES USTED MISMO. SOLICITE LOS TRABAJOS DE SERVICIO AL PERSONAL CALIFICADO.

Reclamaciones de aparatos de patentes de los Estados Unidos de América número 4,631,603, 4,577,216 y 4,819,098, con licencia para usos de visión limitada solamente.
Este producto incorpora tecnología de protección de los derechos de autor que está protegida por reclamaciones de métodos de ciertas patentes de los Estados Unidos de América y otros derechos de propiedad intelectual propiedad de Macrovision Corporation y otros propietarios de derechos. La utilización de esta tecnología de protección de los derechos de autor debe contar con la autorización de Macrovision Corporation, y sólo deberá utilizarse en el hogar y con otros usos de visión limitada a menos que Macrovision Corporation autorice lo contrario. La inversión de la ingeniería o el desmontaje están prohibidos.

Panasonic welcomes you to our ever growing family of electronic product owners. We know that this product will bring you many hours of enjoyment. Our reputation is built on precise electronic and mechanical engineering, and our products are manufactured with carefully selected components and assembled by people who take pride in their work. Once you discover the quality, reliability, and value we have built into this product, you too will be proud to be a member of our family.

Use This Product Safely

When Driving

The driver must not operate the color LCD monitor. Operating the color LCD monitor may lead to distraction and cause an accident. Stop your car in a safe location when operating the unit.

When Washing Your Car

Do not expose the product to water or excessive moisture. This could cause electrical shorts, fire or other damage.

When Parked

Parking in direct sunlight can produce very high temperatures inside your car. Give the interior a chance to cool down before switching the unit on.

Use the Proper Power Supply

This product is designed to operate with a 12 V DC, negative ground battery system (the regular system in a North American car).

Protect the Disc Mechanism

Avoid inserting any foreign objects into the slot of the player. Failure to observe this may cause malfunction due to the precise mechanism of this unit.

Protect the DVD Software

When you leave the car, be sure to eject the disc from this unit and bring it out.

Use Authorized Servicenters

Do not attempt to disassemble or adjust this precision product. Please refer to the Servicenter list included with this product for service assistance.

For Installation

The unit should be installed in a horizontal position with the front end up at a convenient angle, but not more than 30°.

The user should bear in mind that in some areas there may be restrictions on how and where this unit must be installed. Consult your dealer for further details.

Features

- Digital audio output terminal for upgrading to Dolby Digital and dts surround [Requires separately sold optical cable (CA-LRD60) and digital surround processor (CY-AC300)].
- L/R stereo analog audio outputs (RCA) for connection to existing head unit aux inputs. Video output is composite video (RCA).
- Supplied remote handles multi-function software (multi-language audio-track/subtitle, multi-angle, multi-story, etc.), plus all basic functions.

The figure on the right shows an example of a combination recommended. See pages 40 to 43 for information on how to connect the wires.

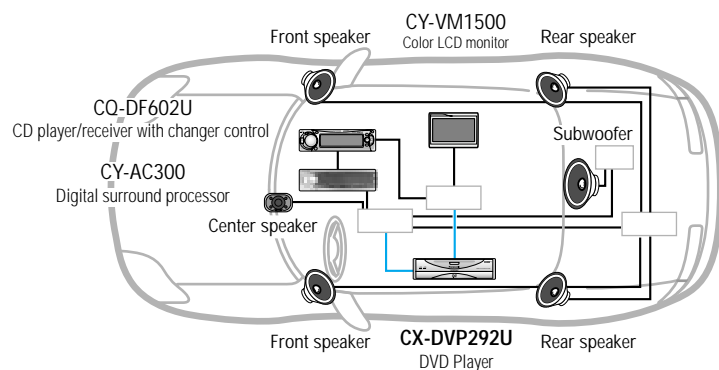

Find the model number and serial number on either the back or bottom of the unit. Please record them in the spaces below and retain this booklet as a permanent record of your purchase to help with identification in case of theft.

MODEL NUMBER CX-DVP292U SERIAL NUMBER DATE PURCHASED FROM

Panasonic est heureuse de vous compter parmi les utilisateurs de ses appareils électroniques. Nous pouvons vous assurer que cet appareil vous procurera de longues heures d'agrément. Notre réputation est fondée sur une ingénierie électronique et mécanique de haute précision, laquelle préside à la fabrication d'appareils ne comportant que des composants de choix assemblés par un personnel soucieux de la bonne réputation acquise par la qualité de son travail. Après avoir découvert la qualité, la valeur et la fiabilité de cet appareil, vous aussi serez fier d'être un client Panasonic.

Précautions à prendre

Au volant

Le conducteur ne doit jamais faire fonctionner le moniteur lorsqu'il conduit son véhicule. Le fait d'utiliser le moniteur lorsqu'on est au volant réduit considérablement la vigilance du conducteur et multiplie les risques d'accident. Arrêtez le véhicule dans un endroit sans danger pour manipuler le moniteur.

Lavage de la voiture

Afin de prévenir tout risque de court-circuit ou d'incendie n'exposez pas l'équipement à l'eau ou à une humidité excessive.

Voiture stationnée

L'habitacle d'une voiture immobile exposée au soleil toutes vitres fermées devient rapidement très chaud. Laissez rafraichir l'intérieur du véhicule avant d'utiliser l'appareil.

Source d'alimentation

Cet appareil est conçu pour fonctionner sur un système d'alimentation avec batterie de 12 V c.c. à masse négative (système standard sur les voitures de construction nord-américaine).

Protection du mécanisme de disque

N'insérez pas de pièce de monnaie ou de petits objets. Gardez les tournevis et autres objets métalliques à l'écran du mécanisme de disque et du disque.

Protection des disques DVD

Lorsque vous quittez le véhicule, éjectez le disque de l'appareil et retirez-le.

Faites appel aux centres de service agréés

N'essayez pas de démonter ou d'ajuster cet appareil de précision. Veuillez consulter la liste des centres de service fournie avec cet appareil pour obtenir de l'aide.

Installation

L'appareil doit être installé en position horizontale avec son extrémité avant inclinée vers le haut à un angle commode et jamais supérieur à 30°.

L'utilisateur doit garder à l'esprit que, dans certaines régions, il peut y avoir des restrictions relatives à la façon d'installer cet appareil et à l'endroit où il doit être installé. Contactez votre détaillant pour plus de détails.

Caractéristiques

- Prise de sortie audio numérique permettant la mise à niveau aux systèmes ambiophoniques Dolby Digital et dts [Nécessite un câble optique (CA-LRD60) et processeur numérique ambiophonique (CY-AC300) vendus séparément].
- Sorties analogiques stéréo G/D (RCA) pour le raccordement aux prises AUX des autoradio actuels. La sortie vidéo est composite (RCA).
- La télécommande fournie est capable de piloter les logiciels multi-fonctions (piste son multi-langues/sous-titres, multi-angles, multi-histoires, etc.) en plus de toutes les fonctions de base.

L'illustration de droite présente un exemple de combinaison recommandée. Référez-vous aux pages 76 à 79 pour les informations relatives au raccordement des fils.

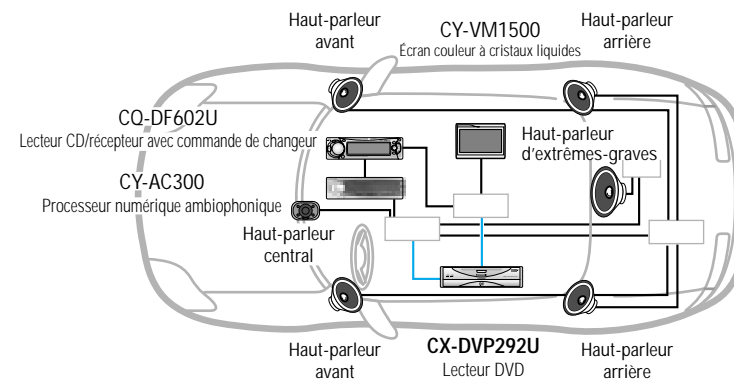

Il est recommandé de noter, dans l'espace prévu ci-dessous, les numéros de modèle et de série inscrits soit à l'arrière soit sur le fond de l'appareil, et de conserver ce manuel comme mémorandum de l'achat afin de permettre l'identification de l'appareil en cas de vol.

NUMÉRO DE MODÈLE CX-DVP292U NUMÉRO DE SÉRIE DATE DE L'ACHAT VENDEUR

Panasonic le da la bienvenida a la familia constantemente en aumento de poseedores de productos electrónicos. Estamos seguros de que este producto le proporcionará muchas horas de distracción. Nos esforzamos en proporcionarle las ventajas de la ingeniería mecánica y electrónica de precisión, de una fabricación con componentes cuidadosamente seleccionados, y de un montaje realizado por personas orgullosas de la reputación que su trabajo ha cimentado para nuestra empresa. Una vez comprobada la calidad, el valor y la fiabilidad incorporados en este producto, usted también se sentirá orgulloso de pertenecer a nuestra familia.

❑ Uso de este equipo con seguridad

Quando conduzca

El conductor no deberá utilizar el monitor LCD en color. La utilización del monitor LCD en color puede producir distracciones y ser la causa de un accidente. Pare su vehículo en un lugar seguro cuando utilice el aparato.

Quando lave el automóvil

No exponga el equipo, al agua o a una humedad excesiva. Esto puede causar cortocircuitos eléctricos, incendios u otros daños.

Quando estacione

El estacionamiento a la luz solar directa puede producir temperaturas muy altas en el interior de su vehículo. Procure enfriar el interior antes de encender la unidad.

Uso de la alimentación apropiada

Este equipo ha sido diseñado para funcionar con un sistema de batería de 12 V CC con negativo a masa (el sistema normal en un vehículo norteamericano).

Protección del mecanismo de los discos

Evite insertar objetos extraños en la ranura del disco. En caso contrario, podrán producirse fallos en el funcionamiento porque el mecanismo de esta unidad es muy preciso.

Protección de los programas de DVD

Cuando salga de su automóvil, asegúrese de expulsar el disco del aparato y retirarlo.

Uso de los centros de servicio autorizados

No intente desmontar ni ajustar este equipo de precisión. Consulte la lista de centros de servicio incluida en este producto para acudir a ellos cuando sea necesario.

Instalación

La unidad deberá instalarse en posición horizontal, con el extremo delantero hacia arriba formando un ángulo conveniente, pero no superior a 30°.

El usuario deberá tener cuenta que en algunas zonas podrá haber restricciones acerca de cómo y dónde deberá instalarse este aparato. Consulte a su distribuidor para conocer más detalles.

❑ Características

- Terminal de salida de audio digital para mejorar a sonido ambiental Dolby Digital y dts [Requiere un cable óptico (CA-LRD60) y procesador de sonido ambiental digital (CY-AC300) vendido separadamente].
- Salidas de audio analógico estéreo I/D (RCA) para conectar a las entradas auxiliares de las unidades principales existentes. La salida de video es del tipo de video compuesto (RCA).
- Control remoto suministrado que controla software de múltiples funciones (pista de audio/subtítulos de múltiples idiomas, múltiples ángulos, múltiples historias, etc.), más todas las funciones básicas.

La cifra de la derecha muestra un ejemplo de combinación recomendada. Véase páginas 112 a 115 para obtener información sobre cómo conectar los cables.

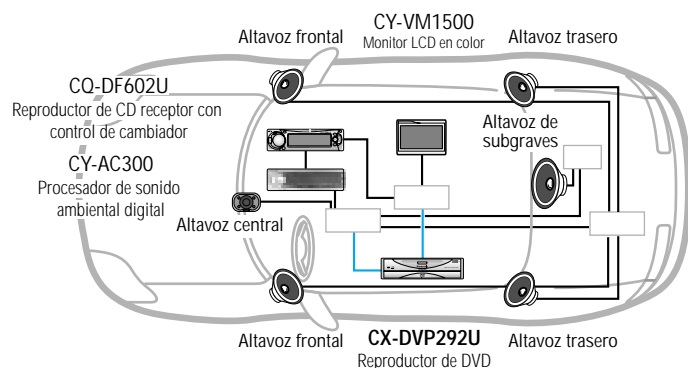

Encuentre el número de modelo y el número de serie en la parte posterior o inferior de la unidad. Anótelos en el espacio de abajo y guarde este manual a modo de prueba permanente de su compra, para que pueda identificar la unidad en el caso de que se la roben.

NÚMERO DEL MODELO CX-DVP292U
 FECHA DE COMPRA _____

NÚMERO DE SERIE _____
 NOMBRE DE LA TIENDA _____



Contents

Preparation

- ❑ Safety Information (2)
- ❑ Use This Product Safely (4)
- ❑ Features (4)
- ❑ Discs that can be Played Back (10)
- ❑ Components/Remote Control Unit Preparation (11)



Disc Operations

Pages 12 – 21

- ❑ Inserting/Ejecting disc, Playback, Stop (13)
- ❑ Selecting a Menu Item (14)
- ❑ Go to Beginning, Fast Forward/Fast Backward (15)
 - ❑ Pause, Slow Playback, Direct Title/Chapter/Track/Folder/File Selection (16)
- ❑ Repeat Play (17)
- ❑ DVD Menu, Title Menu (18)
- ❑ On-Screen Displays (OSD) (19)
- ❑ Switching the Subtitle Language, Switching the Audio Language (20)
- ❑ Switching the Angle, Switching between Stereo and Monaural (21)

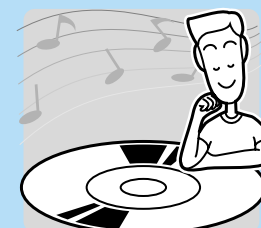

User Settings

Pages 22 – 25

- ❑ Menu Language, Subtitle Language, Audio Language, TV Aspect (22)
- ❑ TV Mode, On-Screen Messages, Audio Output Level, D. Range Compression (24)

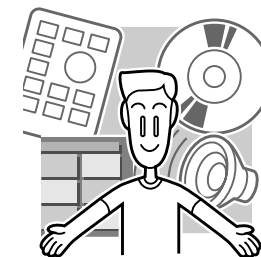

When required

- ❑ Troubleshooting (26)
- ❑ Notes on MP3 (31)
- ❑ Maintenance (34)
- ❑ Notes on CD-Rs/RWs (34)
- ❑ Language Code List (35)
- ❑ Definition of Terms (36)
- ❑ Specifications (45)

Installation

- ❑ Installation Guide (37)
- ❑ Electrical Connections (40)



Discs that can be Played Back

ENGLISH
1

Disc	Mark (logo)	Disc size	Video format	Audio format	Region No.
DVD video		5" (12 cm)	NTSC	LPCM, MPEG 1 MPEG 2, Dolby Digital	1 All
Video CD			NTSC	LPCM, MPEG 1	
CD, CD TEXT		3" (8 cm)		LPCM MP3	

Note:

- With MP3s, only those files whose data has been written in discs can be played back.
- About CD-Rs and CD-RWs, refer to "Notes on CD-Rs/RWs" on page 34.

Example: Region Management Information

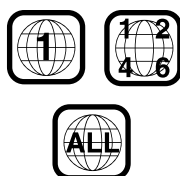

Region Management Information: This product is designed and manufactured to respond to the Region Management Information that is recorded on a DVD disc. If the Region number described on the DVD disc does not correspond to the Region number of this product, this product cannot play this disc.

The Region number for this product is "1" and "ALL".

Symbols used on jackets (Examples of such symbols include)

- Number of subtitle languages
 - Number of audio tracks
 - Number of angles
- The numbers indicate the number of languages, tracks, angles, etc., recorded on the disc.

Screen size (H:V aspect ratio)

- 4:3 standard size
- Letterbox (⇒ page 36)
- 16:9 wide size : Play back in letterbox format on a standard screen (4:3).
- : Play back in "Pan & Scan" (⇒ page 36) format on a standard screen (4:3).

Note:

- The size of the image that is displayed on the screen depends on the screen mode of the monitor, and on screen size for the content on the disc.

The following discs cannot be played back on this product.

- DVD-Audio
- DVD-ROM
- VSD
- CD-RW (except MP3 and LPCM)
- CDV
- Discs recorded in PAL format, others
- DVDs with a region number other than "1" or "ALL"
- DVD-R
- CVD
- Divx Video Discs
- DVD-RAM
- CD-G
- CD-R (except MP3 and LPCM)
- CD-EXTRA (audio-only playback possible)
- DVD+RW
- CD-ROM (except MP3)
- SACD
- DVD-RW
- photo CD

Even if you play back a dts CD and DVD, normal sound cannot be output. (Only digital signals are output.)



Components/ Remote Control Unit Preparation

ENGLISH
2

Components

The numbers in parentheses indicate the accessory quantities.

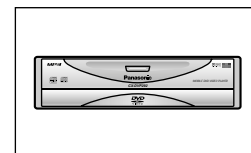

- DVD Player (1)

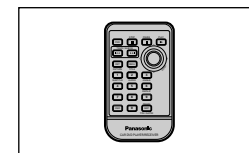

- Remote control unit (1)

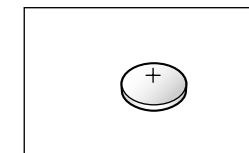

- Lithium battery (CR2025) (1)

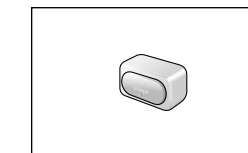

- Remote control signal receiver* (1)

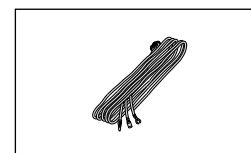

- Power connector (1)

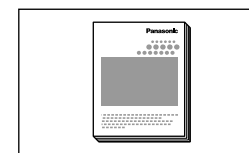

- Operating instructions (1)

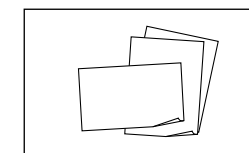

- Warranty card, etc.

- Installation hardware (Screws, cords, etc.) (⇒ page 37)

* The remote control signal receiver is not used when the remote control is operated through the monitor unit (⇒ page 40).

Remote Control Unit Preparation

Battery Installation (Inserting/Replacing the Battery)

- 1 Remove the battery holder.
Pull the battery holder by position B while pushing position A in the direction indicated by the arrow.
- 2 Install the battery on the battery holder.
As shown in the figure on the right, fit the battery into the battery holder with the "+" side facing up while pressing on position A.
- 3 Insert the battery holder.
Push the battery holder back into its original position.

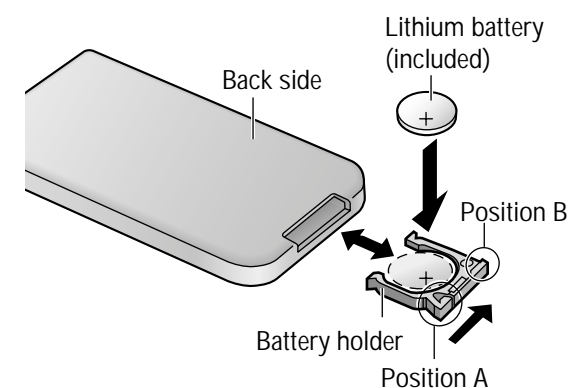

Battery Notes

Remove and dispose of an old battery immediately.

Battery Information:

- Battery type: Panasonic lithium battery (CR2025) (included)
- Battery life: Approximately 6 months with normal use (at room temperature)

Caution:

- Improper use of batteries may cause overheating, an explosion or ignition, resulting in injury or a fire. Battery leakage may damage the unit.

- Do not disassemble or short the battery. Do not throw a battery into a fire.
- Keep batteries away from children to avoid the risk of accidents.
- Be careful to observe proper local disposal rules when you dispose of batteries.

Point the remote control unit at the sensor.



Not all CD media containing MP3 data will play back normally. For details, see "Notes on MP3" (⇒ page 31).

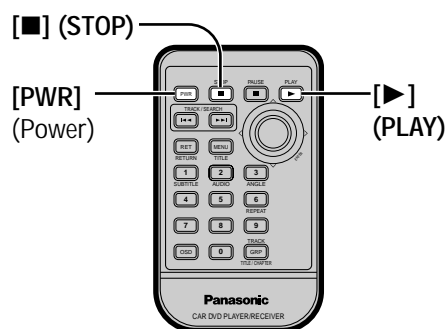
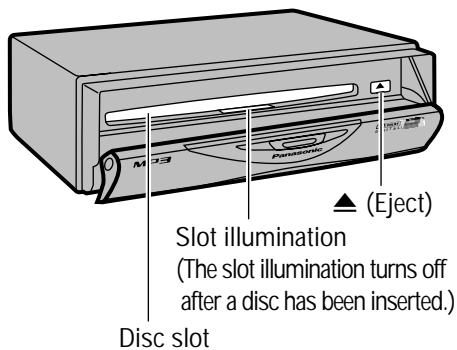

Preparation

Check the monitor connection setting. (⇒ pages 40–43)

Turn the car's ignition switch ACC or ON.
(ACC indicator* lights.)



ACC indicator*

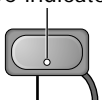

Remote control signal receiver

*ACC indicator lights when the remote control signal receiver is connected. (⇒ page 40)

Turn the monitor switch to ON.

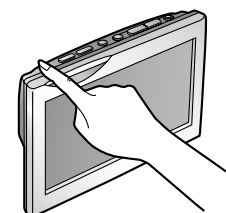

1 Push [PUSH-OPEN] to open the cover and insert the disc.

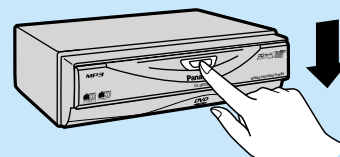

- Before loading a disc, check to make sure that a disc is not already loaded.

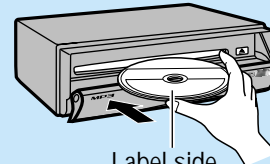

Label side

- The power turns to ON and playback begins automatically.

When a disc is already loaded:



- Turn the power on.

2 Close the cover.

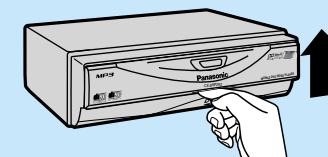

- Always close the cover completely when using the player.

Ejecting the disc:

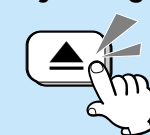

- You can eject the disc even when the power is off.
- You can eject a disc even when ACC is off by pressing [▲] (eject) for a second or more.

To turn the power off:



Caution:

- The player can only play the following types of discs: DVD video, Video CD, CD and CD-DA data recorded CD-R and CD-RW, and MP3 data recorded CD media (CD-ROM, CD-R, CD-RW).
- If a disc contains both CD-DA data and MP3 data, only CD-DA data will be played back.
- Refer to page 34 about notes on CD-Rs/RWs.
- Refer to page 31 about notes on MP3.
- Do not use irregularly shaped discs.
- Do not use discs that have a seal or label attached.
- Do not insert foreign matter into the disc slot.
- Never attempt to play a file that is not in the MP3 format by changing its file name extension to ".mp3". This may produce noise from the speakers and speaker damage, and can damage your hearing.

Note:

- Operations vary according to the disc. For details, refer to the guide provided with the disc.
- When you insert a CD media containing MP3 files (CD-ROM, CD-R, CD-RW) into the slot, this player will automatically enter MP3 mode and start playing the MP3s on the discs.
- If you record too many folders and MP3 files onto a disc, it may take some time before playback starts.
- Since some DVD discs have data recorded on both sides, take care not to mistake top side for the reverse side and vice versa.
- It may take a few moments for play to begin after the disc has been inserted.
- When it is difficult to hear comparatively quiet sounds (such as movie dialogue), setting "Minimum" (⇒ page 24) will make those sounds easier to hear (only Dolby Digital encoded material).
- Only a message as shown right is displayed on the screen while driving the car. Only audio is enabled.

Screen while driving the car

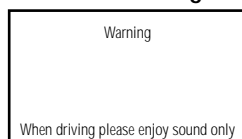

When "⊘" is displayed

Input is not possible because a soundtrack, subtitle language or angle number which was not recorded on the disc has been selected or because the user has attempted to perform an operation which is not supported by the player.

DVD Video Video CD CD MP3

Playback

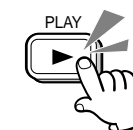

- Playback starts.

Note:

- When the menu screen appears, refer to "Selecting a Menu Item" (⇒ page 14).

DVD Video Video CD CD MP3

Stop

(During playback)

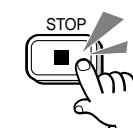

- Playback stops.

Note:

- When play is stopped, the player records the point where [■] (STOP) was pressed (Continued playback function). Press [▶] (PLAY) again, and play will resume from this point.

To cancel continued playback:

- Hold [■] (STOP) for more than 2 seconds again in the stop mode.

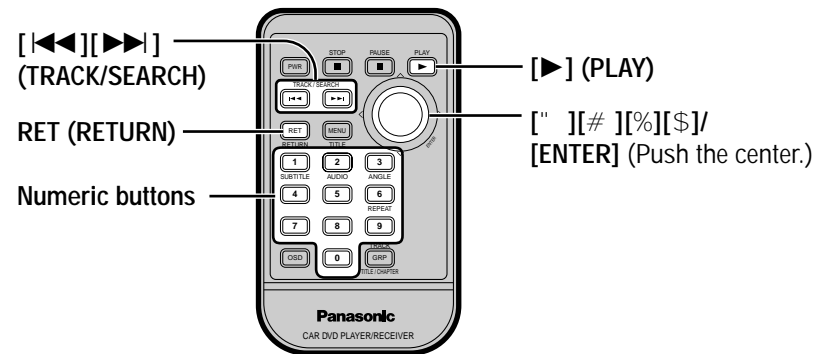

DVD Video Video CD

DVD Video

1 Select Item.

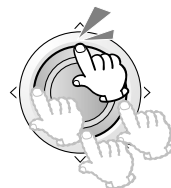

(Example)

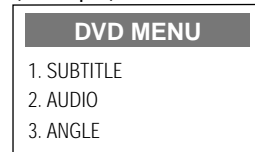

2 Finalize selection (ENTER).

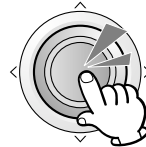

Selecting a Menu Item

DVD Video/Video CD with playback control

1 Select Item.

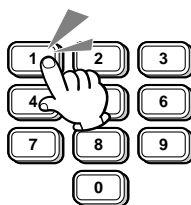

(Example: Video CD with playback control)

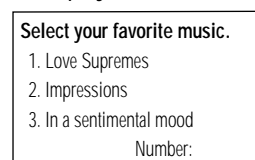

(Example: "1")

To input the number again:



Note:

- Operations vary according to the disc. For details, refer to the guide provided with the disc.

DVD Video Video CD CD MP3

Go to Beginning

DVD Video/Video CD/CD/MP3

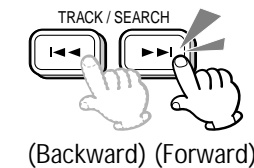

(Backward) (Forward)

- Each time one of these buttons is pressed, the player jumps to the start of the appropriate chapter/track/file.
- If the backward button is pressed once, the player returns to the start of the chapter/track/file that is currently being played.

MP3 only

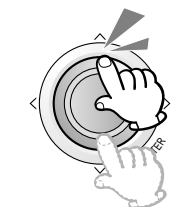

["]:
Next folder

[#]:
Previous folder

- Each time one of these buttons is pressed, the player jumps to the file at the next (or previous) folder.
- Note:**
 - If the selected folder does not contain any MP3 files, the nearest MP3 file in the order of playback will be played.
 - If the total of files and folders exceeds 254, successful playback may not be performed.

DVD Video Video CD CD

Fast Forward/ Fast Backward

Forward

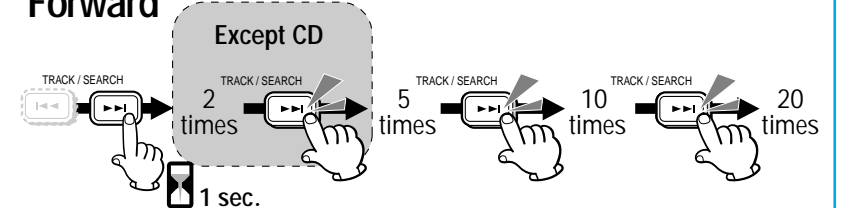

Backward

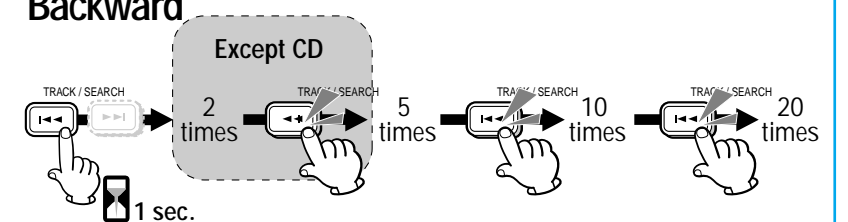

- When [◀◀] (or [▶▶]) is held down for half a second or more during forward search (or backward search) at any speed which is a multiple of the normal playback speed, the forward search (or backward search) is released, and backward search (or forward search) is started.
- When [◀◀] (or [▶▶]) is pressed for less than half a second, the forward (or backward) playback is released.

To resume normal playback:



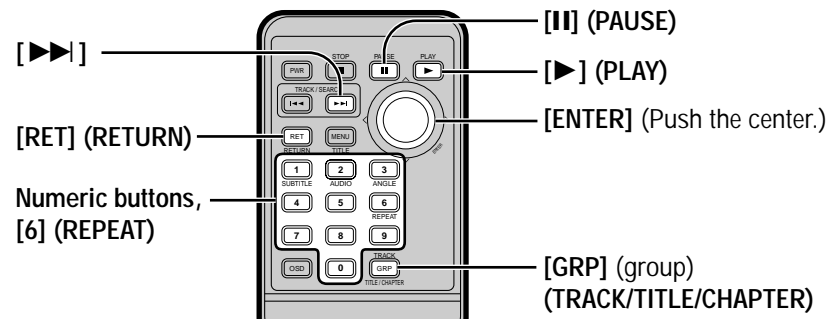

DVD Video	Video CD	CD	MP3
Pause			
(During playback)		When pressing [P] (PAUSE) during pause:	
		DVD Video/Video CD	
<ul style="list-style-type: none"> The playback pauses. 		Each time the button is pressed, the image playback is advanced frame-by-frame.	
		CD/MP3	
		Normal playback is restored.	
To resume normal playback:			

DVD Video	Video CD	
Slow Playback		
(During pause)	To pause:	To resume normal playback:
<ul style="list-style-type: none"> Playback is at approximately 1/3 normal speed. 		<ul style="list-style-type: none"> Reverse slow playback is not possible.

DVD Video	CD	MP3
Direct Title/Chapter/Track/Folder/File Selection		
1 Select the input mode.		
(During playback)		
DVD	CD	MP3
(Regular mode)	(Regular mode)	(Regular mode)
Chapter	Track	File
Title		Folder

DVD Video	Video CD	CD	MP3
Repeat Play			
Chapter/Track (Video CD) Repeat		To resume normal playback:	
(During playback)			
		2 sec.	
DVD Video		The chapter that is currently being played repeats.	
Video CD		The track that is currently being played repeats.	
Note:		<ul style="list-style-type: none"> Repeating is cleared by actions such as fast forward, fast backward, slow play, going to beginning, and stopping. 	
Track (CD)/File Repeat		To resume normal playback:	
(During playback)			
		2 sec.	
CD		The track that is currently being played repeats.	
MP3		The file that is currently being played repeats.	
Note:		<ul style="list-style-type: none"> Repeating is cleared by actions such as fast forward, fast backward, slow play, going to beginning, and stopping. 	

2 Input the desired number.	3 Finalize selection (ENTER).
To input the number again:	<ul style="list-style-type: none"> The corresponding title/chapter/track/folder/file on the selected folder/file starts playing.
	Note:
	<ul style="list-style-type: none"> If a non-existent title/chapter/track/folder/file number is input and entered, the command is invalid and the display returns to regular mode. Title selections (only for DVD video) can be made even in the stop mode.

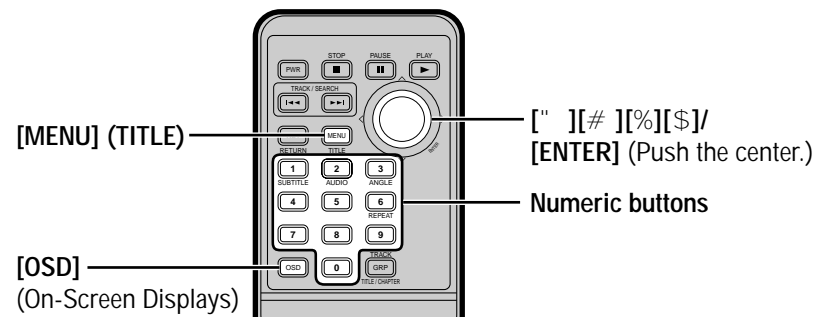

DVD Video

DVD Menu

Use this menu during playback to select content, audio, subtitles, etc., from a menu (the DVD menu) that is unique to each disc.

- (During playback)** (Example)

DVD MENU	
1. SUBTITLE	
2. AUDIO	
3. ANGLE	

 - The DVD menu appears on the screen. (Pressing this button again causes playback to start at the scene from which the DVD menu was called.)
- Select the item.** or (Example: "3")
- Finalize the selection (ENTER).**

DVD Video

Title Menu

If the DVD has multiple titles recorded on it, it is possible to select the preferred title from the title menu to start playback.

- (During playback or stopping)** (Example)

TITLE MENU	
Rivers	Castles
Lovers	Woods

 2 sec.
 - The title menu appears on the screen. (Pressing this button again causes playback to start at the scene from which the title menu was called.)
- Select the item.**
- Finalize the selection (ENTER).**

Note:

- Operations vary according to the disc. For details, refer to the guide provided with the disc.

DVD Video Video CD CD MP3

On-Screen Displays (OSD)

- (During playback) **Each time the button is pressed:**
ON (default) \longleftrightarrow OFF
- In the case of CD, the On-Screen Display cannot be turned off.

Current Operation Mode (Loading, Eject, Play, Pause, Stop, FF, REW, Still, Repeat, Slow Play)

Title Number (DVD Video) **Playback Time**

Folder Number (MP3) **Chapter Number (DVD Video)**
Track Number (CD)
File Number (MP3)

[CD only]
The display automatically differs according to whether CD-TEXT is present.

Regular display \longleftrightarrow

(“No CD-Text” appears for discs without CD-TEXT.)

[MP3 only]
Each time the button is pressed, the folder and file name (up to 31 character spaces) or the normal screen information will be displayed.

Regular display \longleftrightarrow

Note:

- Each display may sometimes show “---”. This is not a malfunction.
- The On-Screen Display may not be displayed properly when the display size (Aspect) of the connected display unit is set to “Zoom”. In this case, select the other display size type: NORMAL, JUST or FULL.

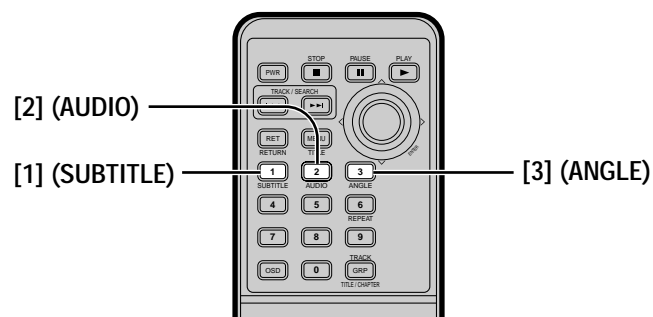

Note:

- If no operation is performed for 5 seconds, the display returns to the regular mode.
- It may not be possible to switch subtitles/audio languages unless the unit is at the DVD menu (⇒ page 18) or is at the user settings (⇒ page 22).
- The number of subtitle languages/audio languages depends on the disc. (Some discs have only one language.)

DVD Video

Switching the Subtitle Language

It is possible to change the subtitle language during play if multiple languages are recorded on the disc.

(During playback)



- The subtitle language is switched every time this is pressed for more than 1 second.
- Initially, the subtitle language is the language that is set in the user settings. (If this language has not been recorded, the language that is displayed is determined by the disc.)

Note:

- There may be brief delay before the subtitles appears.

DVD Video

Switching the Angle

For DVDs which contain scenes which have been shot simultaneously from a number of different angles the same scene can be viewed from each of these different angles during play.

(During playback)

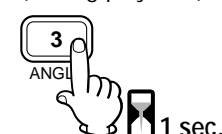

- The angle is switched every time this is pressed for more than 1 second.

Note:

- Some discs do not support the angle function. See the operating manual with the disc for details.

DVD Video

Switching the Audio Language

It is possible to change the audio language during play if multiple audio languages are recorded on the disc.

(During playback)



- The audio language is switched every time this is pressed for more than 1 second.

Video CD

Switching between Stereo and Monaural

(During playback)

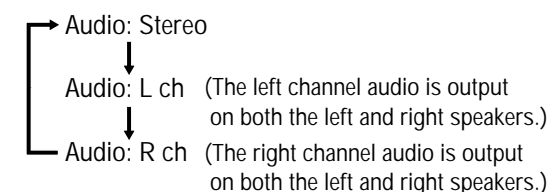
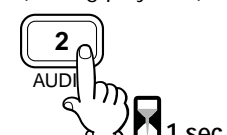

- Stereo is switched to monaural or vice versa every time this is pressed for more than 1 second.



User Settings

1 Display the Main Menu.

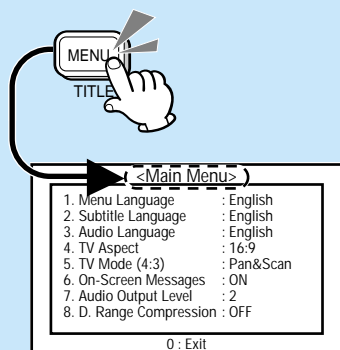

2 Select each setting menu.

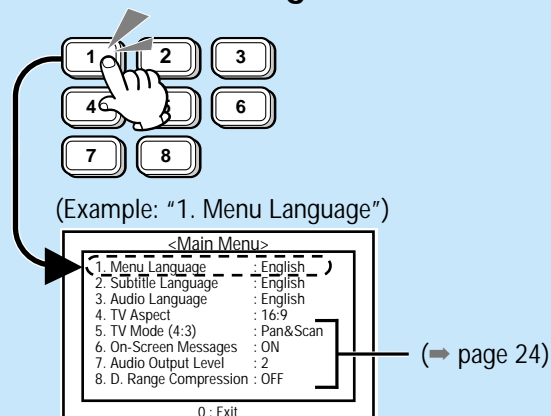

3 Select each item.

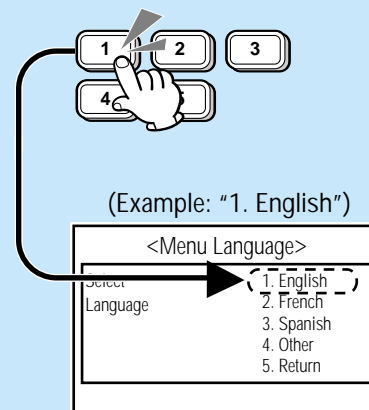

4 Finish the Setting.

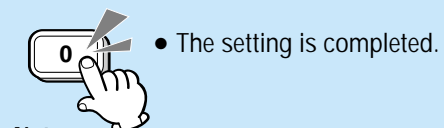

- Note:**
- To apply changes to settings, be sure to press [0] at the end.
 - After the user settings have been changed and entered, the player returns to the start of the disc and begins playback.
 - When the disc has predetermined language or other settings, the user settings are not reflected.

DVD Video

1. Menu Language

[Default: English]

1. English
2. French
3. Spanish
4. Other: => page 35
5. Return: The display returns to "Main Menu".

DVD Video

2. Subtitle Language

[Default: English]

1. English
2. French
3. Spanish
4. Other: => page 35
5. Disp Off: Subtitle language is not displayed.
6. Return: The display returns to "Main Menu".

- Note:**
- A disc supporting closed captioning and subtitles may overlap each other on the screen. In this case, turn the subtitle off.

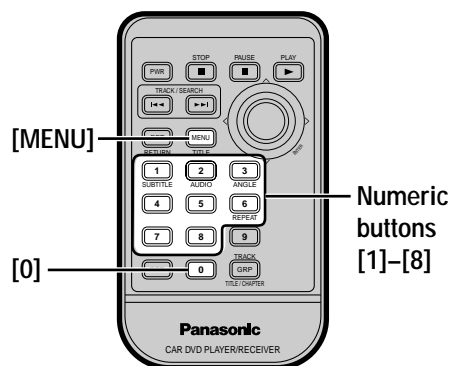

DVD Video

3. Audio Language

[Default: English]

1. English
2. French
3. Spanish
4. Other: => page 35
5. Return: The display returns to "Main Menu".

DVD Video

Video CD

4. TV Aspect

[Default: 16:9]

1. 4:3: When a conventional TV Monitor is connected.
2. 16:9: When a wide-screen TV Monitor is connected.
 - Wide screen video can be played on the full screen.
3. Return: The display returns to "Main Menu".



1 Display the Main Menu.

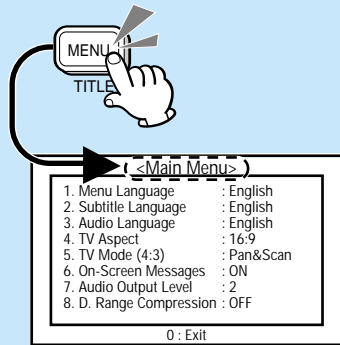

2 Select each setting menu.

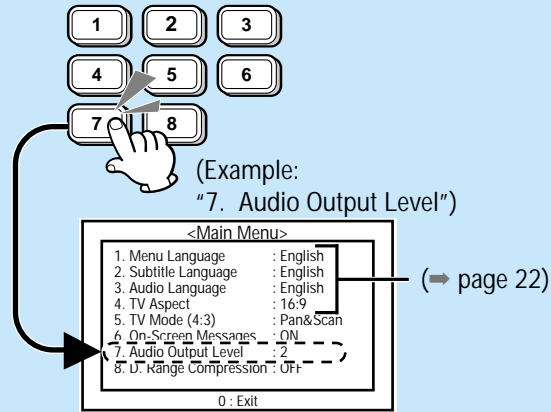

3 Select each item.

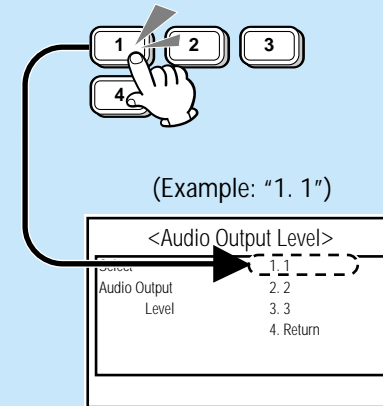

4 Finish the Setting.

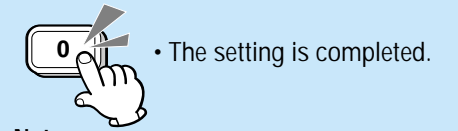

- Note:
- To apply changes to settings, be sure to press [0] at the end.
 - After the user settings have been changed and entered, the player returns to the start of the disc and begins playback.
 - When the disc has predetermined language or other settings, the user settings are not reflected.

DVD Video Video CD

5. TV Mode

Set this when playing wide-screen video on a conventional-size (4:3) TV.
[Default: Pan & Scan]

1. **Pan & Scan:** Plays in Pan & Scan mode
2. **Letterbox:** Plays in Letter Box mode
3. **Return:** The display returns to "Main Menu".

- Note:
- If "Pan & Scan" or "Letterbox" is already set in the software, this setting is ignored.

DVD Video Video CD

6. On-Screen Messages

This is to select On-Screen Display (⇒ page 19) messages which will be displayed when On-Screen Display is turned off by pressing [OSD].
[Default: ON]

1. **ON:** When power is turned on, On-Screen Display messages such as "Play" and "Pause" will always be displayed on the screen for 5 seconds.
2. **OFF:** When power is turned on, On-Screen Display messages such as "Play" and "Pause" will not be displayed on the screen.
3. **Return:** The display returns to "Main Menu".

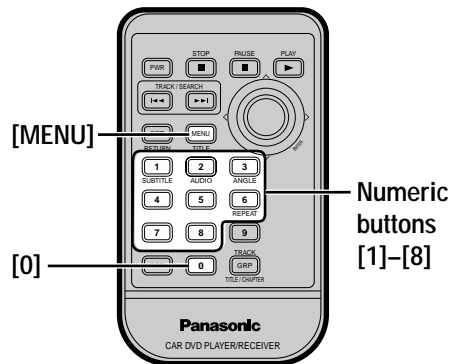

DVD Video Video CD CD MP3

7. Audio Output Level

[Default: 2]

1. 1: Minimum Level
2. 2: Middle level
3. 3: Maximum level
4. **Return:** The display returns to "Main Menu".

- Note:
- We recommend that you select the default when you use this player in the system configurations (⇒ pages 40–43), and adjust the volume control on the display unit or stereo unit concerned to this player. See the display unit operating manual for details.

DVD Video

8. D. Range Compression

By compressing the range of the playback level (the dynamic range), it is possible to maintain the impact of audio even at low volumes.
This function only works with Dolby Digital encoded material.
[Default: OFF]

1. **Minimum:** Most compressed mode: TV broadcasts, etc.
2. **Standard:** Mode recommended by software creators for listening at low volumes.
3. **OFF:** Does not compress the dynamic range.
4. **Return:** The display returns to "Main Menu".

- Note:
- When it is difficult to hear comparatively quiet sounds (such as movie dialogue), setting "Minimum" will make those sounds easier to hear.



Error Display Messages

Error Display	Cause/Step
Playback Error Please eject.	<ul style="list-style-type: none"> • Disc is dirty, scratched or upside down. • A disc that has data other than CD-DA or MP3 type is loaded. <p>⇒ Check the disc.</p> <ul style="list-style-type: none"> • An attempt was made to play a PAL disc. <p>⇒ Eject the disc.</p>
This type of disc cannot be played. Please eject.	<ul style="list-style-type: none"> • Disc is dirty, scratched or upside down. • A disc that has data other than CD-DA or MP3 type is loaded. <p>⇒ Check the disc.</p> <ul style="list-style-type: none"> • An attempt was made to play a PAL disc. <p>⇒ Eject the disc.</p> <ul style="list-style-type: none"> • When there is no MP3 files in the specified folder during direct MP3 folder selection. <p>⇒ Select another folder which contains MP3 files.</p> <ul style="list-style-type: none"> • The player for some reason cannot read the file you are trying to play. (File recorded in an unsupported file system, compression scheme, data format, file name extension, damaged data, etc.) <p>⇒ Select a file that the player can read. Confirm the type of data recorded on the disc. Create a new disc if necessary.</p>
Mechanical Error Please eject.	<p>The unit will not operate for some reason.</p> <p>⇒ Eject the disc. If the disc does not eject when you press [▲] (eject), then simply press the reset switch (⇒ page 30).</p>
This disc may not be played in your region. Please eject.	<p>An attempt was made to play a disc with a region number that was not "1" or "ALL".</p> <p>⇒ Eject the disc.</p>

Troubleshooting Tips

Common

Trouble	Cause/Step
No power.	Car's engine switch is not on. ⇒ Turn your car's ignition switch to ACC or ON.
	Cables are not correctly connected. ⇒ Connect cables correctly.
	Battery cable is not correctly connected. ⇒ Connect the battery cable to the terminal that is always active.
	Accessory cable is not correctly connected. ⇒ Connect the accessory cable to your car's ACC source.

Common (continued)

Trouble	Cause/Step
No power. (continued)	<p>Grounding wire is not correctly connected. ⇒ Connect the grounding wire to a metal part of the car.</p> <p>Fuse is burnt out. ⇒ Call the store where you purchased the unit, or your nearest Servicenter (see the attached sheet) and ask for fuse replacement.</p>
No sound.	<p>Cables are not correctly connected. ⇒ Connect cables correctly.</p> <p>Condensation (dew). ⇒ Wait for a while before use.</p>

DVD/Video CD/CD

Trouble	Cause/Step
The disc is inside but there is no sound.	Disc is upside down. ⇒ Place disc in the correct direction with the label side up.
	Disc is dirty, or has scratches. ⇒ Clean disc, or change the disc referring to the section on "Notes on Disc".
	⇒ The player can only play the following types of discs: DVD video, Video CD, CD and CD-DA data recorded CD-R and CD-RW, and MP3 data recorded CD media (CD-ROM, CD-R, CD-RW)
	⇒ The unit may not successfully play back a CD-R/RW that is made in combination of writing software, a CD recorder (CD-R/RW drive) and a disc which are incompatible one another. Refer to instructions for the concerned devices for details.
Sound skips, bad sound quality (e.g. caused by noise).	You are trying to play a dts CD or DVD. ⇒ The player cannot play audio on dts CDs or DVDs unless a digital sound processor is used (⇒ pages 42-43).
	Disc is dirty, or has scratches. ⇒ Clean disc, or change the disc referring to the section on "Notes on Disc".
Sound skips due to vibration.	⇒ The unit may not successfully play back a CD-R/RW that is made in combination of writing software, a CD recorder (CD-R/RW drive) and a disc which are incompatible one another. Refer to instructions for the concerned devices for details.
	Mounting angle is over 30°. ⇒ Adjust mounting angle to less than 30°.
Disc is not ejected.	• Disc is defective.
	• Mechanical trouble. ⇒ Open the cover and press [▲] (eject). If the disc still does not eject, press the reset switch (⇒ page 30).



❑ DVD/Video CD/CD (continued)

Trouble	Cause/Step
CD-text is not displayed normally.	Disc is dirty, or has scratches. ⇒ Clean disc, or change the disc referring to the section on "Notes on Disc".
Time is counted but no sound comes out.	The first track of a mix mode disc was reproduced. (Mix mode is a format in which data except music is recorded on a track the first track and music data is recorded on other than the first track in a session.) ⇒ Play back music data recorded on a track other than the first track.
The disc will not play, or else it stops very quickly.	Condensation (dew). ⇒ Wait for a while before use. Disc is dirty, or has scratches. ⇒ Clean disc, or change the disc referring to the section on "Notes on Disc".
The picture does not appear on the monitor.	Cables are not correctly connected. ⇒ Connect cables correctly. ⇒ Check the settings for the monitor itself. ⇒ Stop the car and apply the parking brake.
The buttons do not work.	Some operations are not permitted with certain discs. ⇒ Refer to the guide provided with your disc. Two REMOTE IN connectors are connected. ⇒ Do not connect the remote control signal receiver when remote control signals can be received by the display unit.
Video CD menu playback does not work.	⇒ Menu playback is only possible when playing a video CD that has the playback control feature.
The picture becomes distorted while fast forwarding or reversing.	⇒ A certain amount of distortion is normal.
No subtitles appear.	Subtitles must be recorded on the disc, or they will not appear. ⇒ Refer to the guide provided with your disc.
It is difficult to hear quite sounds.	⇒ Set "D. Range Compression" setting to "Minimum".
The sound volume level is too low or too high.	⇒ Adjust the output level setting at the menu of "Audio Output Level".
Cannot switch the radio language/subtitle language/angle.	<ul style="list-style-type: none"> It is not possible to switch if the disc does not have multiple audio languages/subtitle languages/angles recorded on it. ⇒ Refer to the guide provided with your disc. Some discs permit switching through a menu screen. Sometimes, switching angles is possible only with certain scenes.

❑ DVD/Video CD/CD (continued)

Trouble	Cause/Step
The audio/subtitle language selected in the user settings is not used.	If audio or subtitles in that language are not recorded on the disc, the audio or subtitles do not switch to that language. (Some discs permit switching through a menu screen.) ⇒ Refer to the guide provided with your disc.
Messages in the menu screen are not in the desired language.	⇒ Check the setting for "Menu Language" in the user settings.
❑ MP3	
No playback.	The disc does not conform to any of the file systems supported by this player. ⇒ Insert a disc that conforms to the file systems supported by this player. For supported file systems, see "Notes on MP3". The MP3 files is missing the ".mp3" file name extension. ⇒ Make sure to add the ".mp3" extension to each MP3 file name.
It takes too long for playback to start.	The folders and files recorded on the disc are layered too much. ⇒ As checking of files takes longer in this case, do not record any unnecessary folders or files other than MP3s on the disc.
Poor recording quality, sound skipping.	⇒ The recording quality differs depending on the encoding software used, and on settings such as the bit rate. Set the bit rate within the range specified in the specifications chart (⇒ page 45). It is recommended to set the bit rate to "128 kbps or more" and "Fixed". High-speed writing was executed when MP3 data was recorded on the disc. ⇒ Decrease writing speed as low as possible.
Files are not played in the desired order.	Files or folders are not recorded in the desired playback order. ⇒ Some writing software lets you specify the recording order by adding a prefix in the range of "01"-"99", etc. to the file name. For details, refer to the user manual of your writing software.
Folder/file name is not displayed correctly.	The disc does not conform to the file systems supported by this player. ⇒ Insert a disc that conforms to the file systems supported by this player. For supported file systems, see "Notes on MP3". ⇒ There may be a problem with your writing software or CD recorder (CD-R/RW drive). For details, refer to the user manual of your writing software.



MP3 (continued)

Trouble	Cause/Step
File playing time is not displayed correctly.	You ran turned off the ignition switch of the car during playback. → Playing another file will return the file playing time to normal.
	You played a VBR (Variable Bit Rate) format MP3 file. → The file playing time of VBR (Variable Bit Rate) format MP3 file is sometimes displayed incorrectly.

Remote Control Unit

Trouble	Cause/Step
Buttons are invalid for operation.	Battery polarities are reversed. → Insert the battery correctly.
	Wrong battery. → Check the battery.
	The battery has run down. → Replace the battery.
	Remote control unit is facing the wrong direction. → Direct the remote control unit at the sensor.

Maintenance

Your product is designed and manufactured to ensure a minimum of maintenance. Use a soft cloth for routine exterior cleaning. Never use benzine, thinner or other solvents.

Product Servicing

If the suggestions in the charts do not solve the problem, we recommend that you take it to your nearest authorized Panasonic Servicenter. The product should be serviced only by a qualified technician.

Replace the Fuse

Use fuses of the same specified rating (5 A). Using different substitutes or fuses with higher ratings, or connecting the product directly without a fuse, could cause fire or damage to the unit.

If the replacement fuse fails, contact your nearest Panasonic Servicenter for service.

If the unit begins to operate malfunctionally

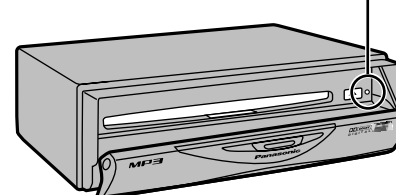

Reset Switch
When you press this switch with a tough pointed object, the user setting is restored after irregular recovery. And, all your settings will be canceled.

Caution:

- Press this switch when any operation buttons do not work. If the unit does not become restored even after pressing the switch, contact your nearest Panasonic Servicenter for service.



This player allows you to play MP3 files recorded on CD-ROMs, CD-Rs (recordable) and CD-RWs (rewritable). About CD-Rs and CD-RWs, see "Notes on CD-Rs/RWs" on page 34.

What is MP3?

MP3, short for MPEG Audio Layer-3, is a standard for compressing digital audio data adopted for video CDs and similar media. It is one of the audio compression schemes covered by MPEG's (Motion Picture Experts Group) digital audio compression standards. What it does is reduce the number of bytes in a song without hurting the sound quality by means such as eliminating big sound waves within in the sound range that is imperceptible to the human ear. This compression allows you to reduce the contents of a conventional music CD by a factor of around 10. This means that you can record the contents of 10 music CDs on a single CD-R or CD-RW. (The figures refer to data recorded on a 650 MB CD-R or CD-RW at a fixed bit rate of 128 kbps and a sampling frequency of 44.1 kHz.)

Points to Remember When Recording an MP3 Disc

Converting (encoding) audio data to an MP3 file

- It is recommended to set the bit rate to "128 kbps or more" and "Fixed".
- Bit rate 8 kbps of MPEG 2 and sampling frequency 16 kHz of MPEG 2 cannot be reproduced.
- If set to VBR (Variable Bit Rate), the file playing time may not be displayed correctly.
- The playback sound quality differs depending on the encoding software and the bit rate. For details, refer to the user manual of your encoding software.

Recording MP3 files on CD-R/RW

- Do not record files other than MP3s or unnecessary folders on a disc.**
If too many folders or files other than MP3s are recorded on a disc, it may take some time before playback starts.
- Use ISO 9660 file system (Extension of the ISO 9660 file systems are included.) (→ page 32). APPLE HFS file system is not supported.**
If they do not conform to the ISO 9660 file system, the file may not play normally, or the file or folder names may not be displayed correctly.
- Make sure to add the ".mp3" extension to each MP3 file name.**
A file with a different file name extension or none at all will not play.
- Although Multi session recording is supported, the use of Disc-at-Once is recommended.**
Make sure to close the session when you finished recording on a disc.
- ID3 Tag Ver. 2 and up are not supported.**
With ID3 Tag Ver. 2 and up, the song information is stored but not displayed.
- Packet writing software is not supported.**
- A playlist function is not supported.**
Record files and folders in the order in which you want them to be played. Some writing software lets you specify the recording order by adding a prefix in the range of "01"–"09", etc. to the file name. For details, refer to the user manual of your writing software.

Note:

- You may encounter trouble in playing MP3s or displaying the information of MP3 files recorded with certain writing softwares or CD recorders (CD-R/RW drives).



Caution:

- Never assign the ".mp3" file name extension to a file that is not in the MP3 format. This may not only produce noise from the speakers and speaker damage, but can damage your hearing.

Note:

- MP3 encode software and writing software are not supplied to this model.

Maximum Number of Files/Folders

- Maximum number of trees: 8
- Maximum number of files/folders: 254 (files+folders. Root folder is not included.)

Note:

- If the total of files and folders exceeds 254, successful playback may not be performed.

Supported File Systems and File Names

Supported file system	Displayable folder names and file names
ISO 9660 Level 1	<p>Name file and folders in accordance with the standard of each file system. Refer to the instructions of writing software for details.</p> <ul style="list-style-type: none"> • This player can display file names of up to 60 ASCII character set in scroll mode. *Up to 30 letters can be displayed when scrolling in the Joliet systems. According to the standard, "á", "ç", etc. can be used. However, this unit cannot display those letters.
ISO 9660 Level 2	
Joliet*	
Romeo	
Apple Extension to ISO 9660	
	<ul style="list-style-type: none"> • Characters that the player cannot display are shown as an asterisk.

Glossary

ISO 9660

The most common international standard for the logical format for files and directories.

APPLE HFS

The file system used by the Macintosh operating system to organize data. **(Not supported)**

Multi-session

A method of adding data incrementally to a CD-R or CD-RW in more than one recording session.

Disc-at-Once

A method of writing data in a media by just one operation and no more writing after that.

ID3 Tag

A function that allows character information (title, artist, album title, date, etc) to be written onto the disc. **(ID3 Tag Ver. 2 and up are not supported.)**

Packet writing

A method of writing data on a CD media in small increments. **(Not supported)**

ASCII character set

ASCII character set consisting of A to Z, a to z, digits 0 to 9, and the following symbols: (space) ! " # \$ % & ' () * + , - . / : ; < = > ? @ [\] ^ _ ` { | } ~

Copyright

It is prohibited by copyright laws to copy, distribute and deliver copyrighted materials such as music without the approval of copyright holder except enjoying yourself personally.

Folder Selection Order/MP3 file playback order (Example)

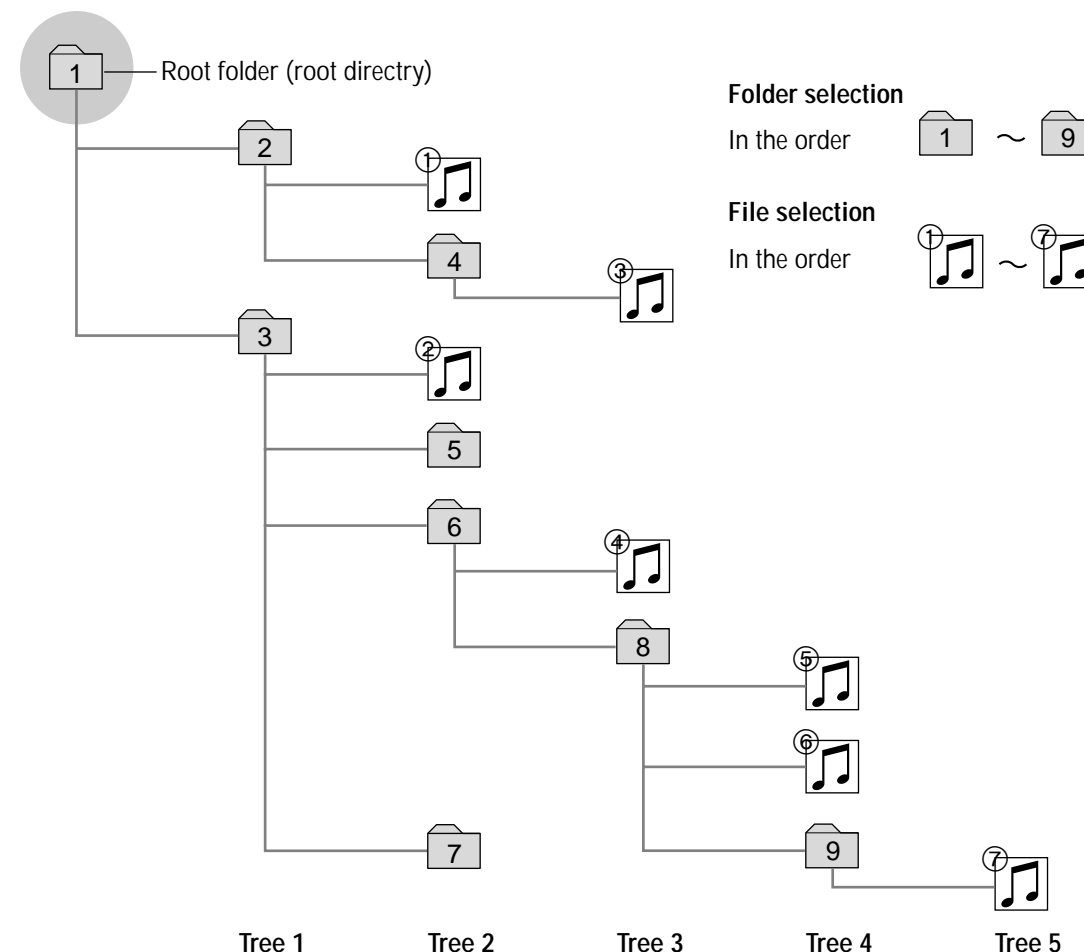

Note:

- This unit counts the number of the folders irrespective of the presence or absence of MP3 file. (Example: there is no MP3 file in a root folder as shown in the drawing, but a folder number "001" is given. In fact, there is no MP3 file to reproduce. Therefore, the next folder is automatically selected.)
- The writing software sometimes changes the order of folders and files on a disc, so the order may differ from what you specified. For details, refer to the user manual of your writing software.
- If you record too many folders or files other than MP3 onto a disc, it may take some time before playback starts.
- Playback order varies with players even if the same disc is loaded.
- If a disc contains both CD-DA and MP3 data, only CD-DA data will be played back.
- If the ignition switch of your car is turned to OFF during playback, there may be a time lag between the file playing time on the display and the actual playing time. In addition, playback may start from the beginning of the music when using VBR (Variable Bit Rate) of a MP3 file in the same situation.



Care of the Unit

☐ Cleaning this Unit

Use a dry, soft cloth to wipe.

☐ Caution on Cleaning

Never use solvents such as benzene or thinner as they may mar the surface of the unit.

Notes on Disc

How to hold the disc

- Do not touch the underside of the disc.
- Do not scratch the disc.
- Do not bend the disc.
- When not in use, keep the disc in the case.

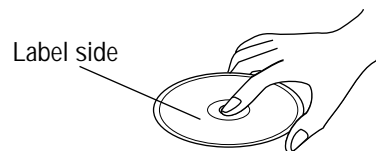

Do not use irregularly shaped discs.

Do not leave discs on the following places:

- Direct sunlight
- Near car heaters
- Dirty, dusty and damp areas
- Seats and dashboards

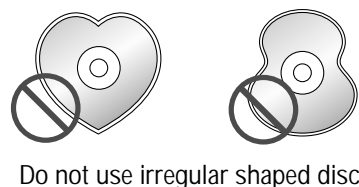

Do not use irregular shaped discs.

Disc cleaning

Use a dry, soft cloth to wipe from the center outward.

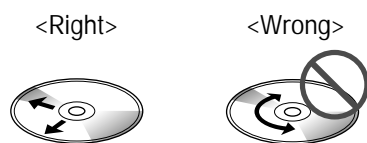

Rough edges

Caution on new discs

A new disc may have rough edges on its inner and outer perimeter. These may cause malfunction. Remove the rough edges using a pencil, etc.

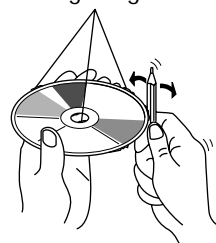

Do not attach any seals or labels to your discs.

Do not write on the disc label in a heavy pen or ball-point pen stroke.

Notes on CD-Rs/RWs

- You may have trouble playing back some CD-R/RW discs recorded on CD recorders (CD-R/RW drives), either due to their recording characteristics or dirt, fingerprints, scratches, etc. on the disc surface.
- CD-R/RW discs are less resistant to high temperatures and high humidity than ordinary music CDs. Leaving them inside a car for extended periods may damage them and make playback impossible.
- The unit may not successfully play back a CD-R/RW that was made by the combination of writing software, a CD recorder (CD-R/RW drive) and a disc if they are incompatible one another.
- This player cannot play the CD-R/RW discs if the session is not closed.
- This player cannot play the CD-R/RW discs which contains other than CD-DA or MP3 data (video CD, etc.).
- Be sure to observe the instructions of CD-R/RW disc for handling it.

In "Other" cases (Menu Language, Subtitle Language, Audio Language) (→ page 22)

1 Input the four digit language code. (See below.)

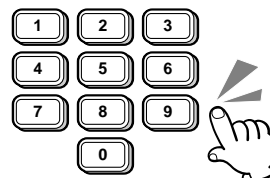

To input the number again:



2 Finalize the selection (ENTER).

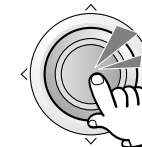

- Setting is finished and the display returns to "Main Menu".

Code	Language Name
6565	Afar
6566	Abkhazian
6570	Afrikaans
6577	Ameharic
6582	Arabic
6583	Assamese
6588	Aymara
6590	Azerbaijani
6665	Bashkir
6669	Byelorussian
6671	Bulgarian
6672	Bihari
6678	Bengali; Bangla
6679	Tibetan
6682	Breton
6765	Catalan
6779	Corsican
6783	Czech
6789	Welsh
6865	Danish
6869	German
6890	Bhutani
6976	Greek
6978	English
6979	Esperanto
6983	Spanish
6984	Estonian
6985	Basque
7065	Persian
7073	Finnish
7074	Fiji
7079	Faroese
7082	French
7089	Frisian
7165	Irish
7168	Scots Gaelic
7176	Galician
7178	Guarani
7185	Gujarati
7265	Hausa
7273	Hindi
7282	Croatian

Code	Language Name
7285	Hungarian
7289	Armenian
7365	Interlingua
7378	Indonesian
7383	Icelandic
7384	Italian
7387	Hebrew
7465	Japanese
7473	Yiddish
7487	Javanese
7565	Georgian
7575	Kazakh
7576	Greenlandic
7577	Cambodian
7578	Kannada
7579	Korean
7583	Kashmiri
7585	Kurdish
7589	Kirghiz
7665	Latin
7678	Lingala
7679	Laothian
7684	Lithuanian
7686	Latvian, Lettish
7771	Malagasy
7773	Maori
7775	Macedonian
7776	Malayalam
7778	Mongolian
7779	Moldavian
7782	Marathi
7783	Malay
7784	Maltese
7789	Burmese
7865	Nauru
7869	Nepali
7876	Dutch
7879	Norwegian
7982	Oriya
8065	Panjabi
8076	Polish
8083	Pashto, Pushto

Code	Language Name
8084	Portuguese
8185	Quechua
8277	Rhaeto-Romance
8279	Romanian
8285	Russian
8365	Sanskrit
8368	Sindhi
8372	Serbo-Croatian
8373	Singhalese
8375	Slovak
8376	Slovenian
8377	Samoan
8378	Shona
8379	Somali
8381	Albanian
8382	Serbian
8385	Sundanese
8386	Swedish
8387	Swahili
8465	Tamil
8469	Telugu
8471	Tajik
8472	Thai
8473	Tigrinya
8475	Turkmen
8476	Tagalog
8479	Tonga
8482	Turkish
8484	Tatar
8487	Twi
8575	Ukrainian
8582	Urdu
8590	Uzbek
8673	Vietnamese
8679	Volapük
8779	Wolof
8872	Xhosa
8979	Yoruba
9072	Chinese
9085	Zulu



Digital audio output connector (Optical)

The digital audio output connector (optical) converts electrical signals into optical signals and transfers them to the amplifier. Consequently, it has a number of features including its immunity from electrical interference from external sources and its ability to prevent the generation of noise and its minimal effect on the external environment.

Dolby Digital

Dolby Digital is a digital sound compression technique developed by the Dolby Laboratories Licensing Corporation.

Supporting 5.1-channel surround sound, as well as stereo (2-channel) sound, this technique enables a large quantity of sound data to be efficiently recorded on a disc.

Manufactured under license from Dolby Laboratories. "Dolby" and the double-D symbol are trademarks of Dolby Laboratories. Confidential unpublished works. © 1992–1997 Dolby Laboratories. All rights reserved.

Interactive DVD

An interactive DVD is DVD software which includes multiple angles, multiple plot endings, etc.

Letterbox screen

This refers to a screen on which the playback picture of wide-screen DVDs or Video CDs appears with black bands running along the top and bottom.



Linear PCM audio (LPCM)

This refers to a signal recording format used in CDs. While CDs are recorded in 44.1 kHz/16 bit, DVDs are recorded in 48 kHz/16 bit up to 96 kHz/24 bit, thus achieving higher quality audio than that of CDs.

MPEG (Moving Picture Experts Group)

MPEG is an international standard format for the compression of motion video as defined by the Moving Picture Experts Group, a working committee which functions under the auspices of the International Standardization Organization and International Electrotechnical Commission. The Group established the MPEG 1 standard in 1991 and the MPEG 2 standard in 1994. MPEG 2 builds on MPEG 1 with many improvements, and it yields a higher picture quality level.

Pan & Scan screen

This refers to a screen on which the playback picture of wide-screen DVDs or Video CDs is cut off at the left and right sides.



Playback control (Video CD)

If the Video CD has "With Playback Control" or others written on the disc surface or on the jacket, the scenes or information to be viewed (or listened to) can be selected interactively with the screen by looking at the menu shown on the screen.

In these instructions, playback using the menu screen is referred to as the "menu play" for video CDs. This player supports Video CDs with playback control.

Title, Chapter (DVD)

DVDs are divided into some large sections (titles) or some small sections (chapters). Each section is numbered; these numbers are called "Title number" or "Chapter number".

Title 1			Title 2	
Chapter 1	Chapter 2	Chapter 1

Track (Video CD/CD)

Video CDs or CDs are divided into some sections (tracks). Each section is numbered; these numbers are called "Track number".

Track 1	Track 2	Track 3	Track
---------	---------	---------	-------------



WARNING

The installation information is designed for experienced installers and is not intended for non-technical individuals. It does not contain warnings or cautions of the potential dangers involved in attempting to install this product.

Any attempt to install this product in a motor car by anyone other than a qualified installer could cause damage to the electrical system and could result in serious personal injury or death.

Installation Hardware

No.	Item	Diagram	Q'ty
①	Tapping screws (5 mmφ × 16 mm)		4
②	Screw with washers (5 mmφ × 6 mm)		4
③	L-shaped brackets		2
④	Power connector		1
⑤	Clamp connector		1
⑥	Cord clamp		1

Caution:

- This unit operates with a 12 V DC negative ground auto battery system only. Do not attempt to use it in any other system. Doing so could cause serious damage.

Before you begin installation, look for the following items which are packed with your unit.

- Warranty Card...Fill this out promptly.
- Panasonic Servicenter List for Service Directory...Keep for future reference in case the unit needs servicing.

Required Tools

You'll need a screwdriver, and the following:

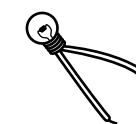

12 V DC Test Bulb



Electrical Tape



Side-cut pliers

Overview

This product should be installed by a professional. However, if you plan to install this unit yourself, your first step is to decide where to install it. The instructions in these pages will guide you through the remaining steps:

(Please refer to the "WARNING" statement above.)

- Identify and label the car wires.
- Connect the car wires to the wires of the power connector.
- Check the operation of the unit.

If you encounter problems, please consult your nearest professional installer.



Identify All Leads

The first step in installation is to identify all the car wires you'll use when hooking up your sound system.

As you identify each wire, we suggest that you label it using masking tape and a permanent marker. This will help avoid confusion when making connections later.

Note:

- Do not connect the power connector to the unit until you have made all connections. If there are no plastic caps on the stereo hooking wires, insulate all exposed leads with electrical tape until you are ready to use them. Identify the leads in the following order.

Power Lead

If your car has a radio or is pre-wired for one: Cut the connector wires one at a time from the plug (leaving the leads as long as possible) so that you can work with individual leads.

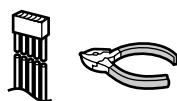

Turn the ignition on to the accessory position, and ground one lead of the test bulb to the chassis.

Touch the other lead of the test bulb to each of the exposed wires from the cut radio connector plug. Touch one wire at a time until you find the outlet that causes the test bulb to light.

Now turn the ignition off and then on. If the bulb also turns off and on, that outlet is the car power lead.

If your car is not wired for an audio unit: Go to the fuse block and find the fuse port for radio (RADIO), accessory (ACC), or ignition (IGN).

Battery Lead

If your DVD player has a yellow lead, you will need to locate the car's battery lead. Otherwise you may ignore this procedure. (The yellow battery lead provides continuous power to maintain a clock, memory storage, or other function.)

If your car has a radio or is pre-wired for one: With the ignition and headlights off, identify the car battery lead by grounding one lead of the test bulb to the chassis and checking the remaining exposed wires from the cut radio connector plug.

If your car is not wired for an audio unit: Go to the fuse block and find the fuse port for the battery which is usually marked BAT.

Connect All Leads

Now that you have identified all the wires in the car, you're ready to begin connecting them to the DVD player wires. The electrical connections (→ pages 40–44) show the proper wiring and color coding of the leads.

We strongly recommend that you test the unit before making a final installation.

You can set the unit on the floor and make temporary connections to test the unit. Use electrical tape to cover all exposed wires.

Important:

- Connect the red power lead last, after you have made and insulated all other connections.

Ground

Connect the black ground lead of the power connector to the metal car chassis.

Battery

Connect the yellow battery lead to the correct radio wire or to the battery fuse port on the fuse block.

Power

Connect the red power lead to the correct power cord according to your system configuration by referring to the wiring diagram.

If the unit functions properly with all these connections made, disconnect the wires and proceed to the final installation.

Final Installation

Lead Connections

Connect all wires, making sure that each connection is insulated and secure. Bundle all loose wires and fasten them with tape so they won't fall down later.

Congratulations! After making a few final checks, you're ready to enjoy your mobile DVD player.

Final Checks

- Make sure that all wires are properly connected and insulated.
- Turn on the ignition to check the unit for proper operation.

If you have difficulties, consult your nearest authorized professional installer for assistance.

Preparation

- We strongly recommend that you wear gloves for installation work to protect yourself from injuries.

- Disconnect the cable from the negative \ominus battery terminal (see caution below).
- Unit should be installed in a horizontal position with the front end up at a convenient angle, but not more than 30° .

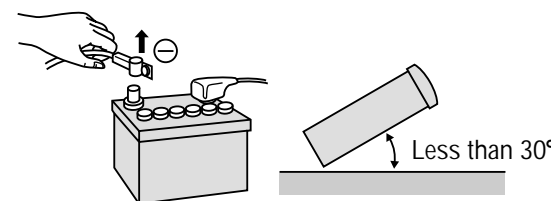

Caution:

- Do not disconnect the battery terminals of a car with a trip or navigational computer since all user settings stored in memory will be lost. Instead take extra care with installing the unit to prevent shorts.

How to install the unit

The diagram below shows an example in which this unit is installed to the floor. Consult a qualified servicing engineer or your dealer for information on installing this unit to a different location.

When Installing the unit with the L-Shaped Brackets ③

- Attach the L-shaped brackets ③ on both sides of unit with the screw with washers ②.

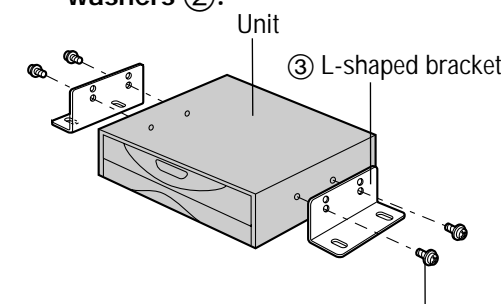

② 4 screws with washers (5 mm ϕ \times 6 mm)

- Install the unit with tapping screws ①.

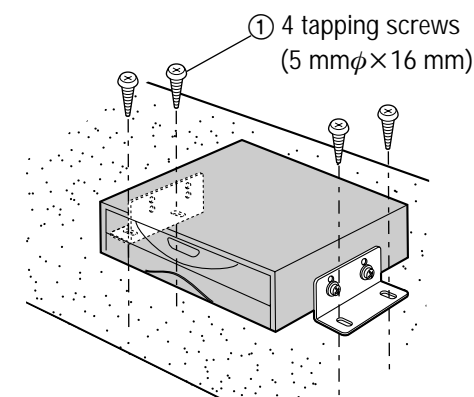

Caution:

- All other installation methods required the use of dedicated metal fittings. Consult with a qualified servicing engineer or your dealer if other methods are required.
- When drilling holes in the car, make sure that you do not damage any pipes or wiring on the underside of the car.
- When installing the unit, make sure that the cord is positioned in a location where it will not be pinched or damaged when the seat slides forward or backward.



Basic System Configuration

Examples of system combination:

- Color LCD monitor (CY-VMX6800U, option)

Accessories for Use

No.	Item	Q'ty
④	Power Connector	1
⑥	Cord Clamp	1

Caution:

- This product is designed to operate with a 12 V DC, negative ground battery system.
- To prevent damage to the unit, be sure to follow the connection diagram below.
- Remove approx. 1/4" (5 mm) of protective covering from the ends of the leads before connecting.
- Do not insert the power connector into the unit until the wiring is completed.
- Be sure to insulate any exposed wires from a possible short-circuit from the car chassis. Bundle all cables and keep cable terminals free from touching any metal parts.
- Remember, if your car has a drive computer or a navigation computer, the data of its memory may be erased when the battery terminals are disconnected.

CX-DVP292U (Rear)

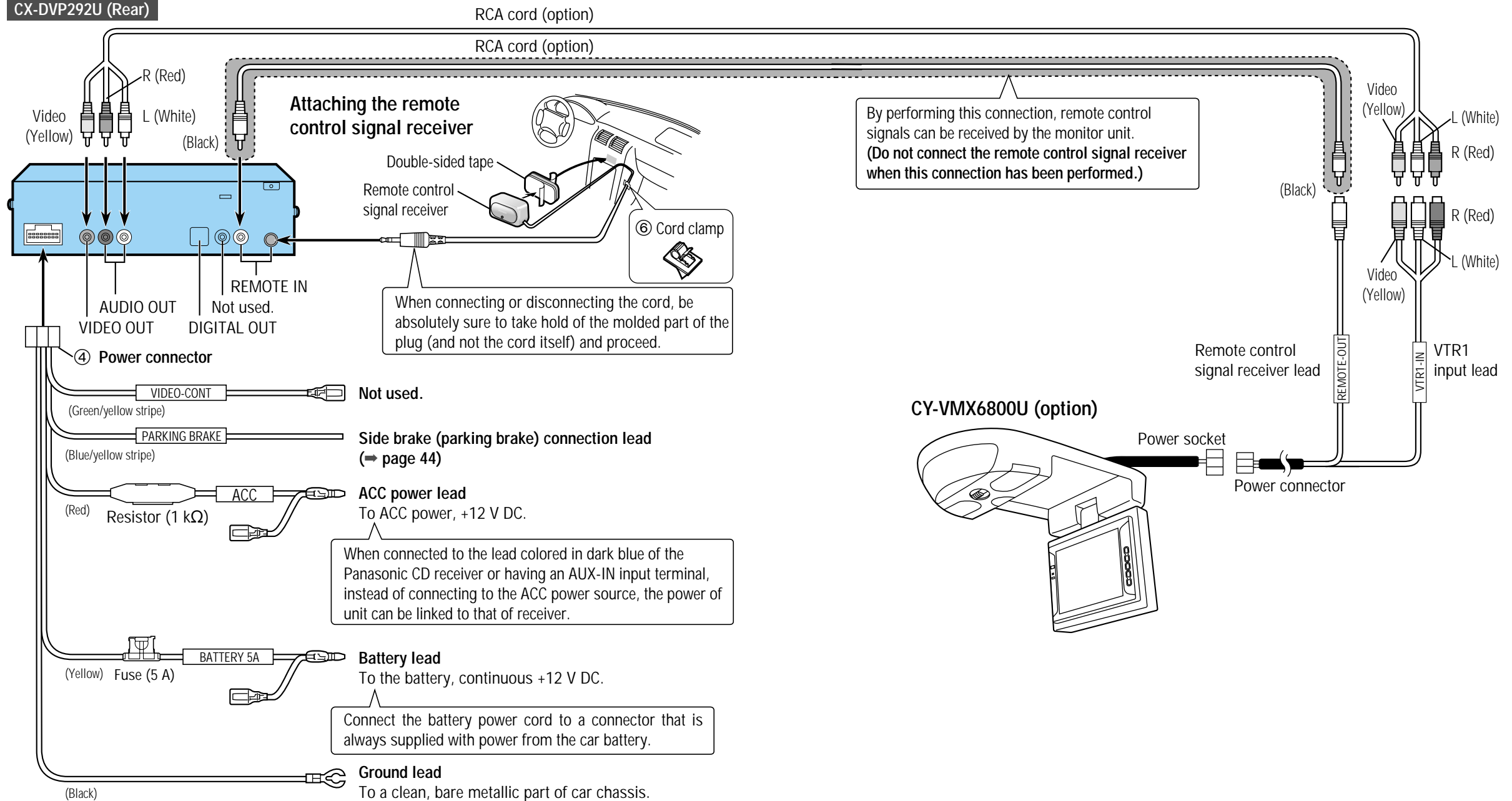



Advanced System Configuration

Examples of system combination:

- Color LCD monitor (CY-VM1500, option)
- Digital surround processor (CY-AC300, option)
- Power amplifier (CY-M9054 or CY-M7052, option)
- CD player/receiver with changer control (CQ-DF602U, option)
- Center speaker (EAB-CF2, option)

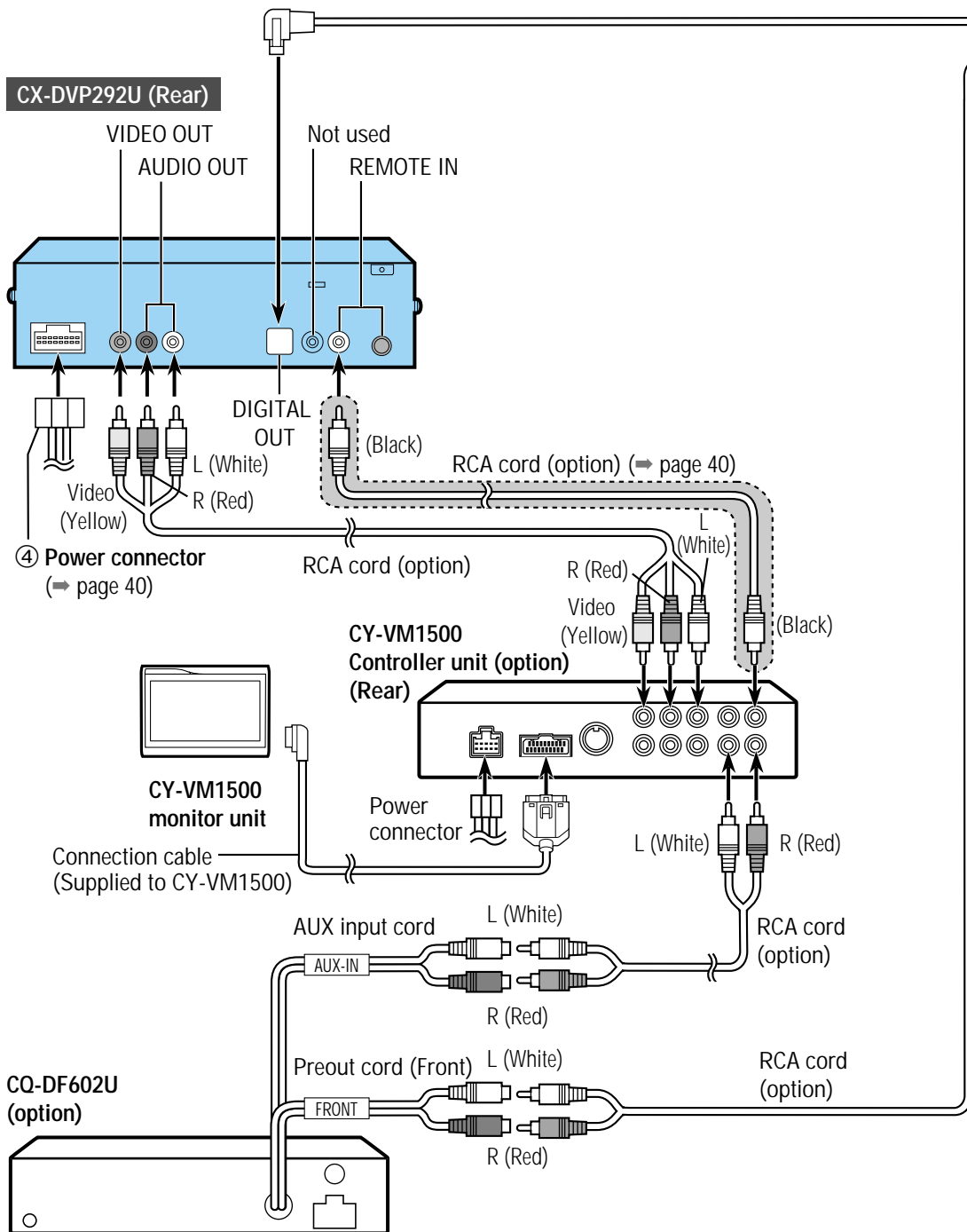

Optical Fiber Cable (CA-LRD60: option)

Notes on handling optical fiber cable:

- Do not bend the cable sharply.
- Do not allow the cable to be damaged by getting it caught in the door, placing a heavy object on it, etc.

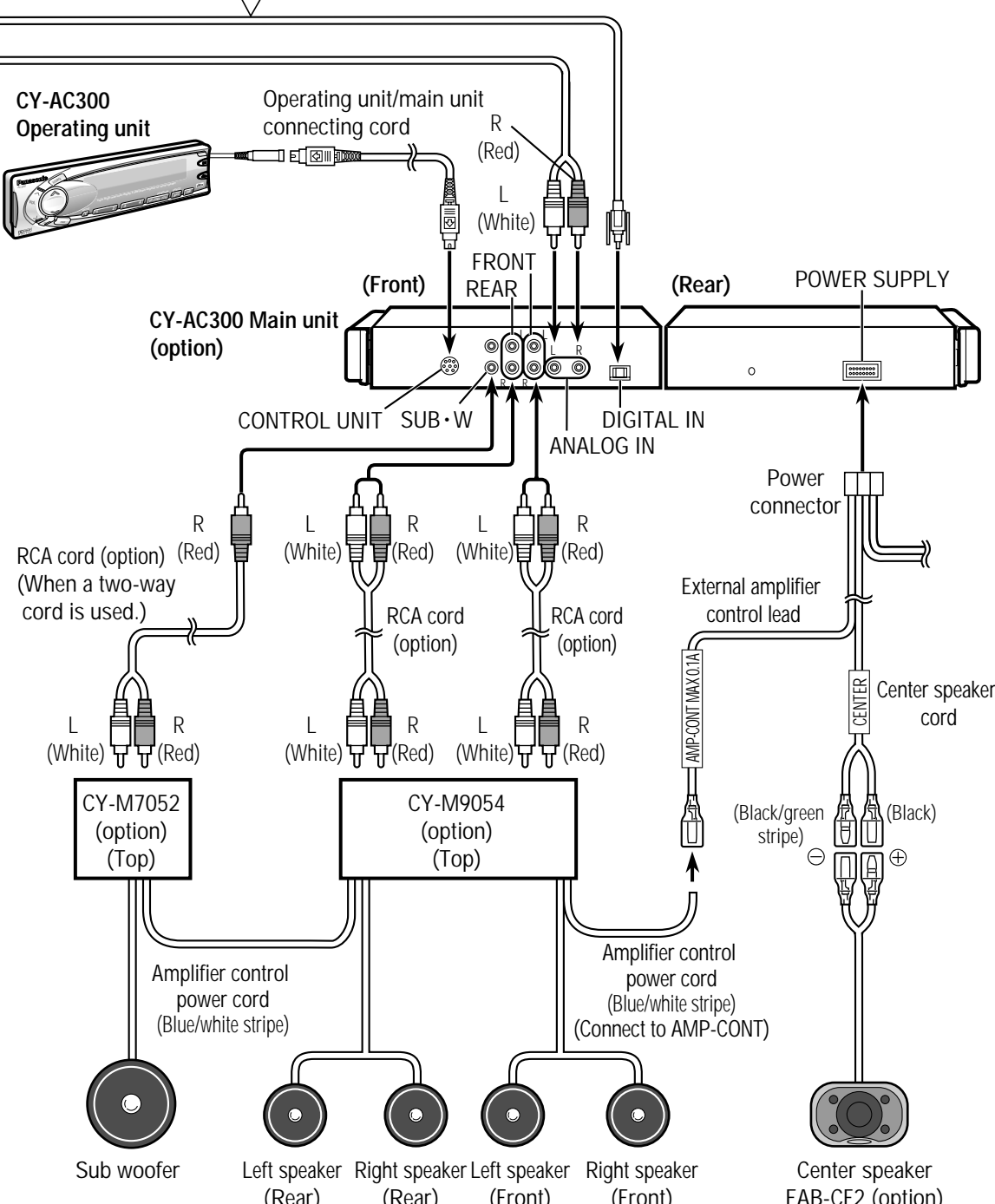



Connecting side brake (parking brake) connection lead

Caution:

- For safety, be sure to ask your nearest professional installer to do this connection.

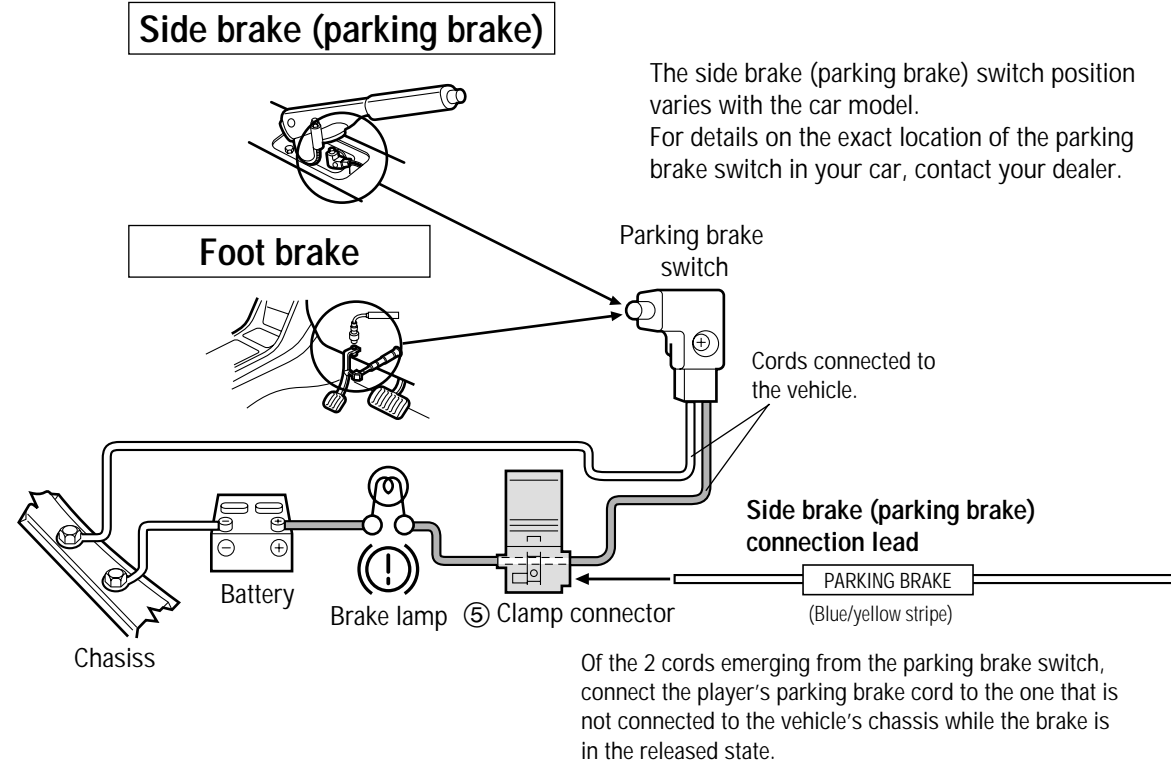

Connecting the Clamp Connector ⑤

- Attach the clamp connector to the vehicle cord at a suitable position.
- Note that if the cord being clamped onto is too thin (0.3 mm² or less), the connection may not be adequate.

- Push the end of the side brake cord into the hole on the clamp connector. Place the vehicle cord into the groove in the clamp connector.
- While making sure that the cords do not slip out of the clamp connector, press the element down with a pair of pliers.
- Close the cover until it snaps shut.

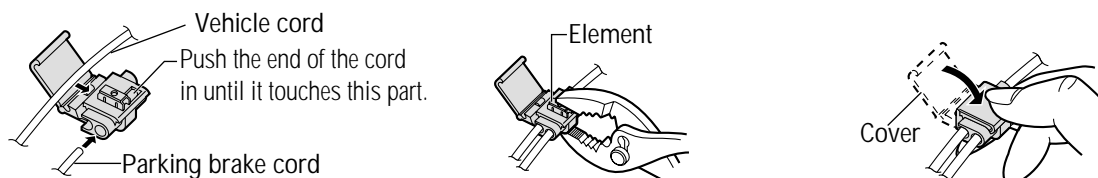

- Supply voltage:** 12 V DC (10.8 V–16 V), test voltage 14.4 V, negative ground
- Current consumption:** Less than 2.0 A
- Signal system:** NTSC 1.0 Vp-p 75 Ω RCA pin jack
- Discs played:**

- DVD-VIDEO disc
 - 5" (12 cm) single-sided, single-layer/double-layer
 - 5" (12 cm) double-sided, single-layer/double-layer
 - 3" (8 cm) single-sided, single-layer/double-layer
 - 3" (8 cm) double-sided, single-layer/double-layer
- Compact disc (CD-DA, VIDEO CD, CD-ROM, CD-R, CD-RW)
 - 5" (12 cm) disc
 - 3" (8 cm) disc

Audio output level: 600 Ω (2 ch 2.5 Vrms Max.)

Audio signal

- output characteristics:**
- Frequency response: 20 Hz–20 kHz
 - S/N ratio: 95 dB (IHF, A)
 - Wow and Flutter: Below measurable limits

Dimensions (W×H×D): 7" × 1⁵/₁₆" × 6¹/₈" (178×50×155 mm)

Weight: 3 lbs. 5 oz (1.5 kg)

Digital audio output:

Disc	Sound recording format	Optical digital audio output from connector
DVD	Dolby Digital	Dolby Digital bitstream (1–5.1 ch)
	DTS*	DTS bitstream (1–5.1 ch) (The analog portion is not output.)
	Linear PCM (48 kHz 16/20/24 bit)	Linear PCM (2 ch) (48 kHz sampling/16 bit only)
Video CD	MPEG 1	MPEG 1 bitstream
	Linear PCM	Linear PCM (2 ch) (44.1 kHz sampling/16 bit)
CD	Linear PCM	Linear PCM (2 ch) (44.1 kHz sampling/16 bit)
	DTS*	DTS bitstream (1–5.1 ch) (The analog portion is not output.)
MP3	MP3	Linear PCM (2 ch) (32 kHz/44.1 kHz/48 kHz sampling/16 bit)

*DTS only works with optical outputs.

"DTS" and "DTS Digital Out" are trademarks of Digital Theater Systems, Inc.

Above specifications comply with EIA standards.

Note:

- Specifications and design are subject to modification, without notice, due to improvements in technology.